

Gelzenleuchter + Ritter GmbH Zeppelinstraße 2 D-47638 Straelen Fon: 02834-98006-0 www.gelzenritter.de		 Masse ohne Toleranzangabe nach "mittel DIN 7168"	Masstab 3:10 Format A3
			Werkstoff
		Datum	Name
	Bearb.	20.07.11	BPF
	[kg]	3,784	
	Wkz		
			Benennung
			A6E Abfallbehälter
			Zeichnungs-Nr.:
			3380 1
			Blatt
			1
			3 Bl.
Zust.	Aenderung	Datum	Name
			10547
			Modelldatei 3380_A6E
			Dateiname 3380

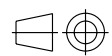

E
1:1

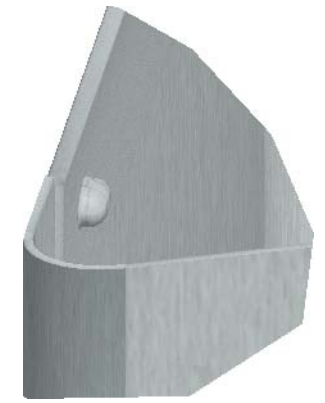
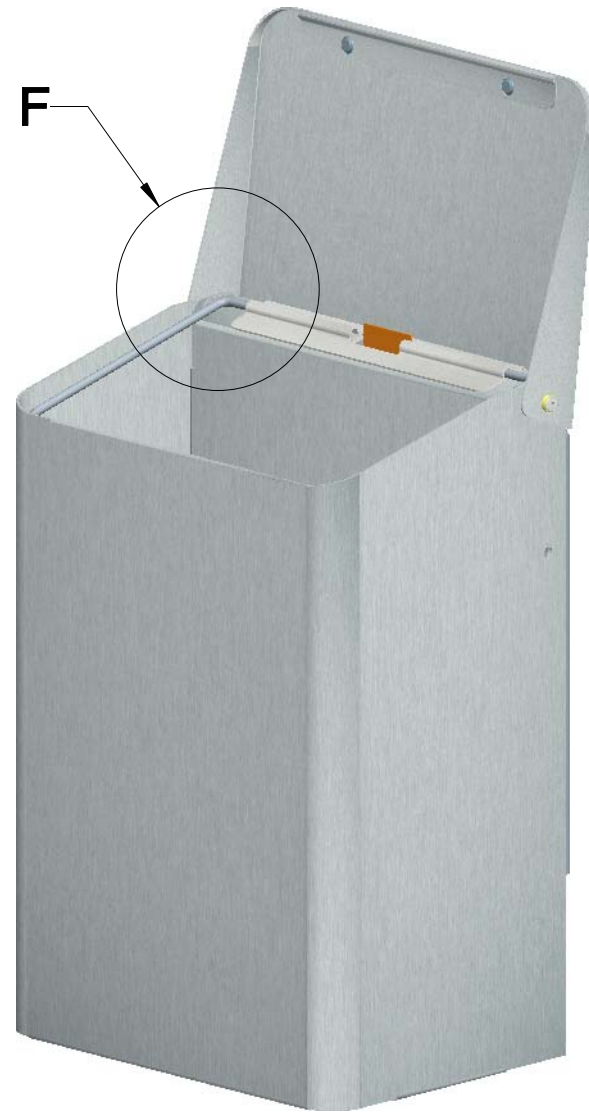
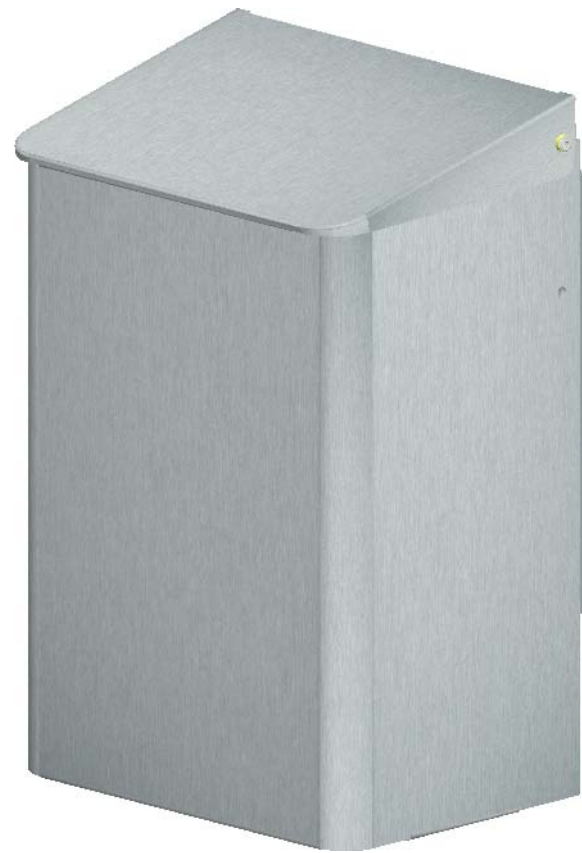
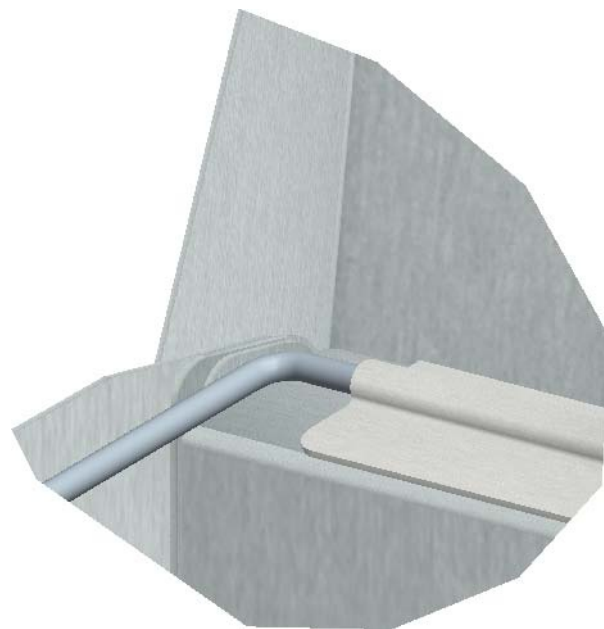
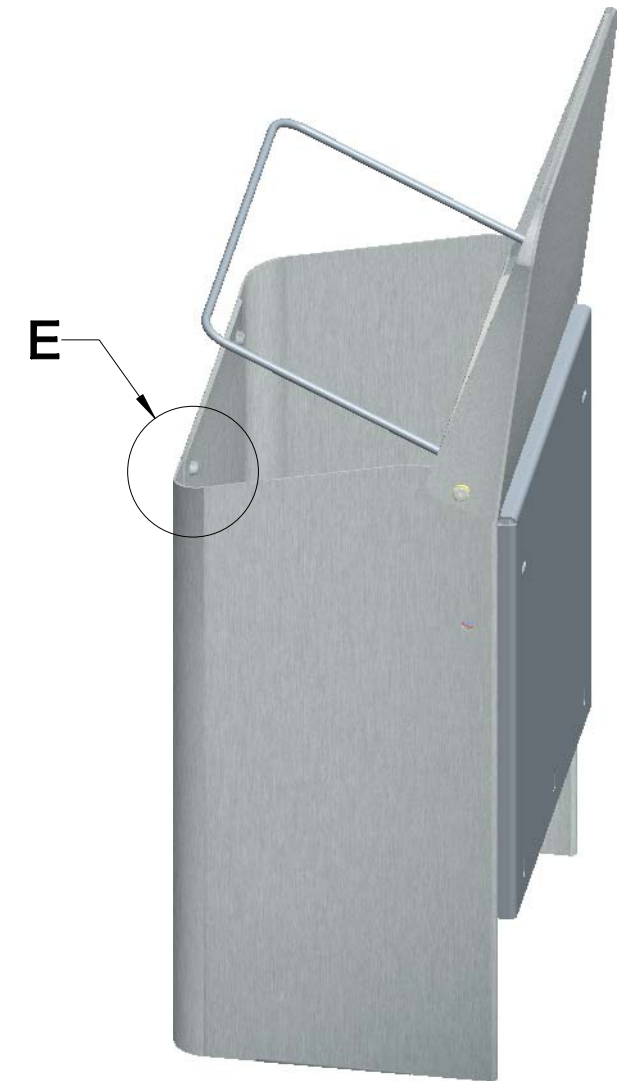

F
1:1

Gelzenleuchter + Ritter GmbH Zeppelinstraße 2 D-47638 Straelen Fon: 02834-98006-0 www.gelzenritter.de		 Masse ohne Toleranzangabe nach "mittel DIN 7168"		Masstab 3:10	Format A3
				Werkstoff	
				Benennung	
				A6E Abfallbehälter	
				Zeichnungs-Nr.:	
				3380 1	
				Blatt	
				2	
				3 Bl.	
10547		Modelldatei 3380_A6E		Dateiname 3380	
Zust.	Aenderung	Datum	Name		

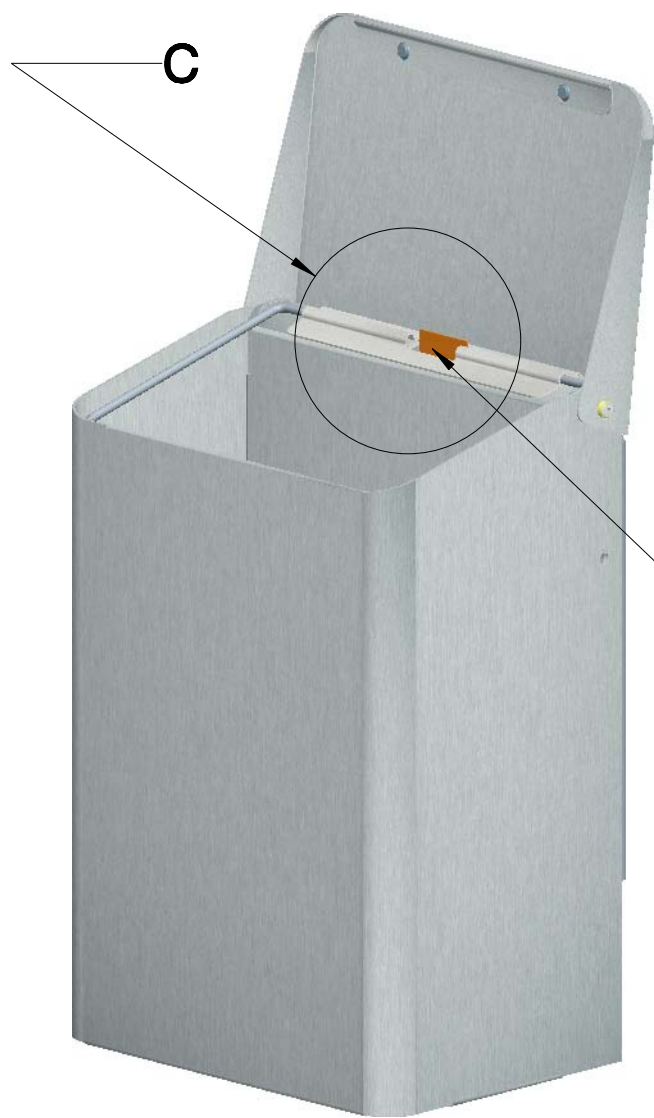

C

Feder nach vorne ziehen

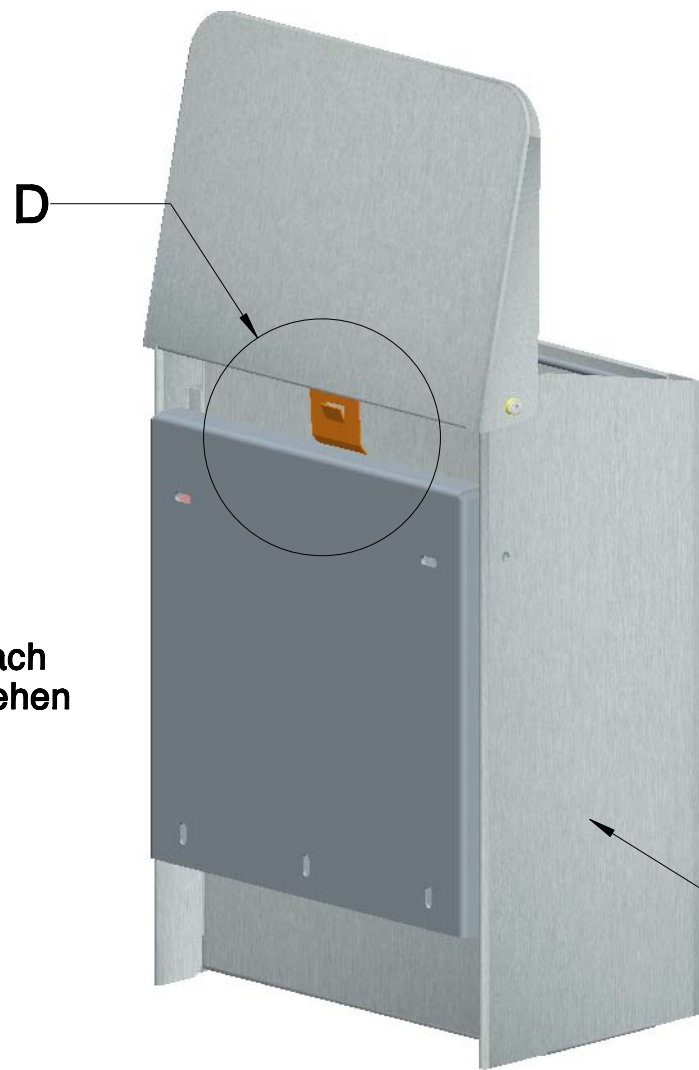

D



Gerät nach oben ziehen und nach vorne von der Wand nehmen



C
1:2

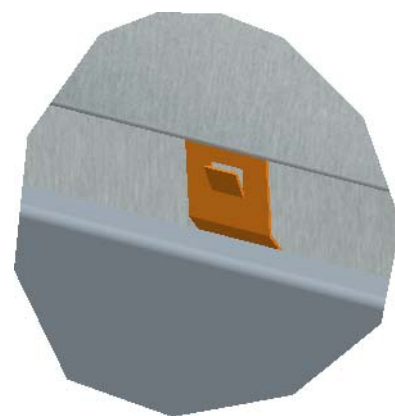

D
1:2

Gelzenleuchter + Ritter GmbH Zeppelinstraße 2 D-47638 Straelen Fon: 02834-98006-0 www.gelzenritter.de		 Masse ohne Toleranzangabe nach "mittel DIN 7168"		Masstab 3:10	Format A3
				Werkstoff	
				Benennung	
				A6E Abfallbehälter	
				Zeichnungs-Nr.:	
				3380 1	
				Blatt	
				3	
				3 Bl.	
10547		Modelldatei 3380_A6E		Dateiname 3380	
Zust.	Aenderung	Datum	Name		