

ART. 0B003060
ART. 0R003060

COMPONENTI

3591	Attacco portamanico	1pz.
S030310	Vaschetta piccola 27x44	1pz.
S030302	Vaschetta verde portasecchi	2pz.
S070310	Portasacco in plastica lt. 120	1pz.
V050018	Set 2 viti Green Line	1pz.
0B003213	Secchio lt. 20	1pz.
000B3502	Secchi lt. 12 blu	1pz.
000R3502	Secchi lt. 12 rosso	1pz.
T090302	Base Green line p.blu c/ruote	1pz.
V050300	Set tappi	1pz.

Struttura rilsan

L320050 Montante rilsan Green Line 2pz.

Struttura blu

L620051 Montante blu Green Line 2pz.



ART. L320050
ART. L620051

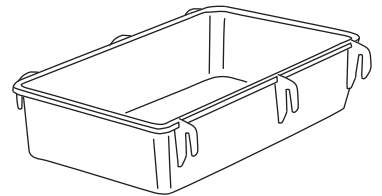

ART. S030310

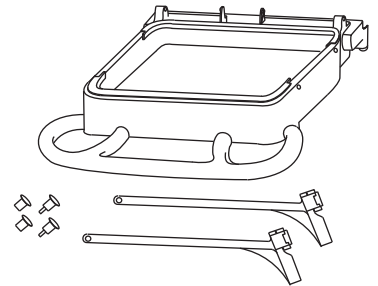

ART. S070310

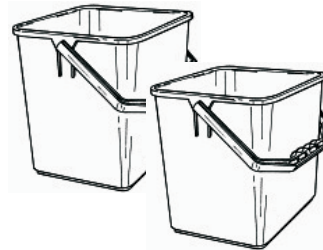

ART. 000B3502
ART. 000R3502

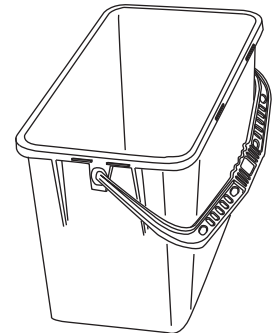

ART. 0B003213

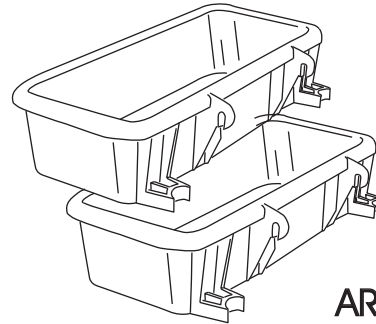

ART. S030302

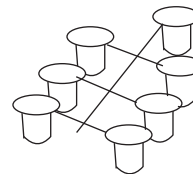

ART. V050300

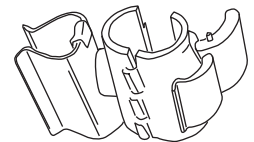

ART. 3591

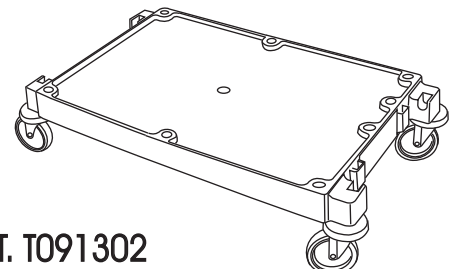

ART. T090302

	ASSEMBLY INSTRUCTION SCHEDA DI MONTAGGIO	REV.2	DATE - DATA 01/11/04
CODE - CODICE 0B003060 - 0R003060		APPROVAL APPROVAZIONE	
PRODUCT - PRODOTTO GREEN LINE 60			

