

Tork Foam Soap Dispenser

S4

Image
Design

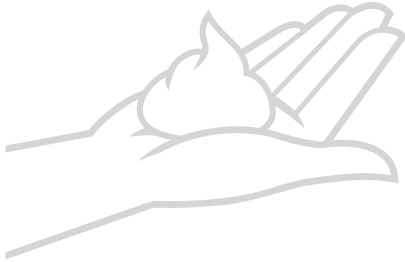
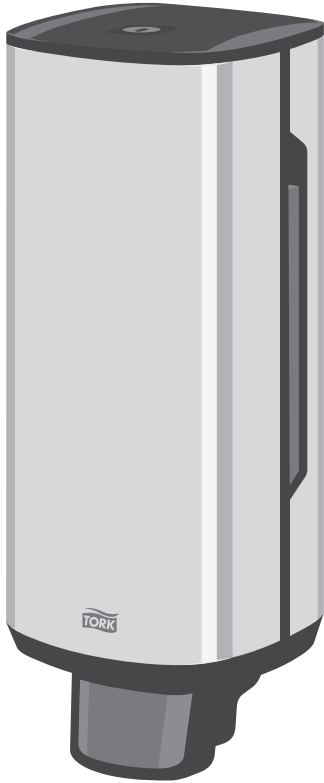

Tork Foam Soap Dispenser

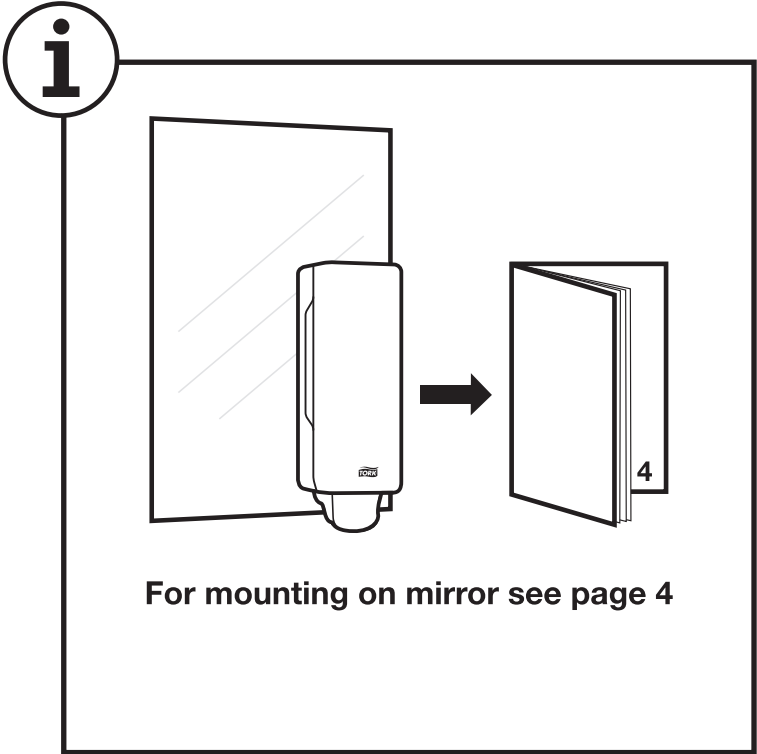
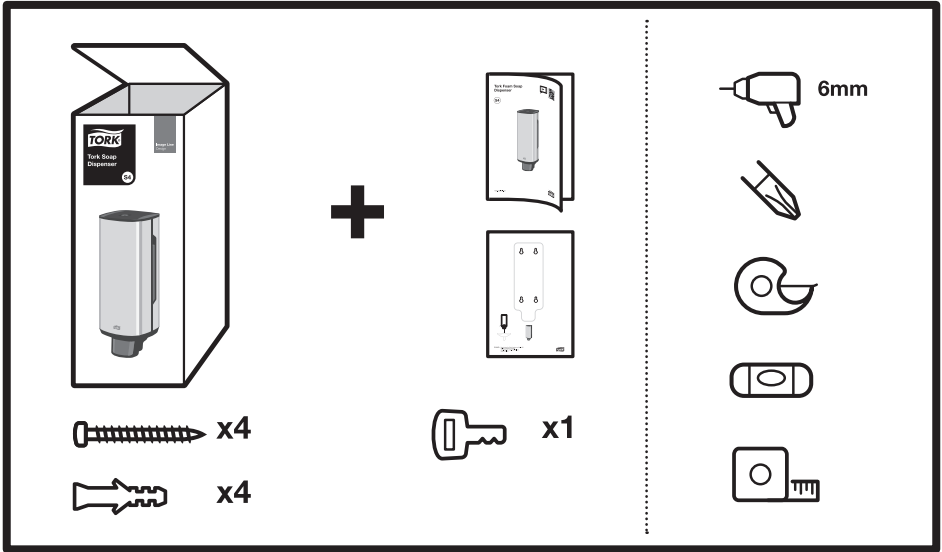

1

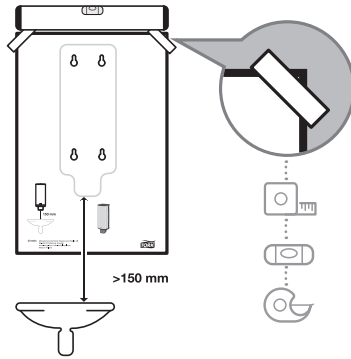

2

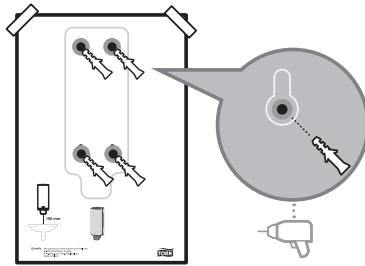

3

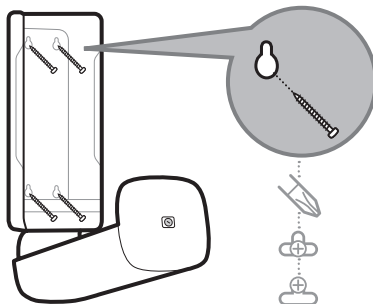

Tork Foam Soap Dispenser

4

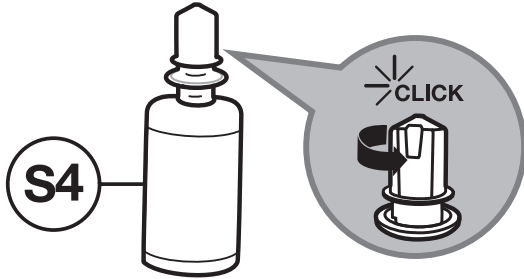

5

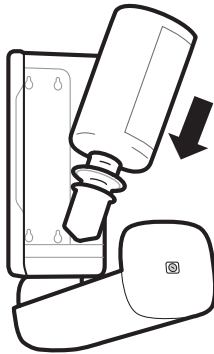

6

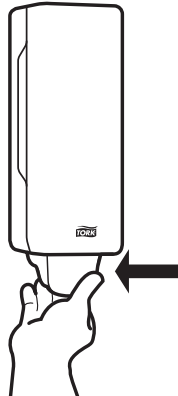

3

i

Mounting on mirror

1

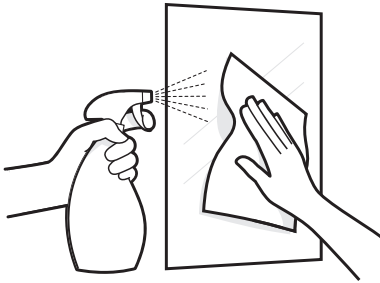

Ensure the mounting surface is flat, clean and dry.

2

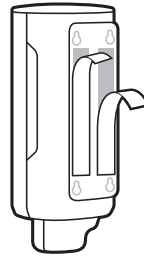

Peel the protective liners from the tape exposing the adhesive.

3

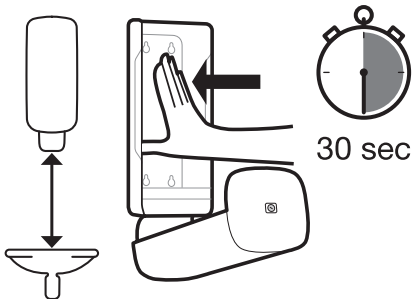

>150 mm

Mount the dispenser to the flat surface, press firmly and hold in place for at least 30 seconds.

4

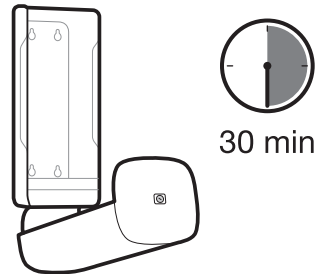

Do not place the refill or batteries in the dispenser for at least 30 minutes.

Tork Foam Soap Dispenser

4

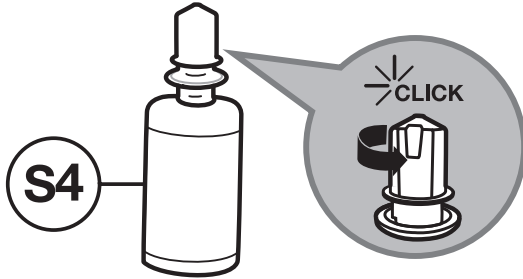

5

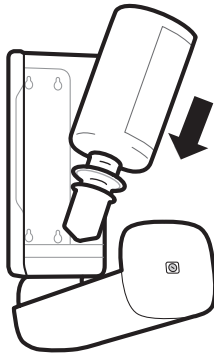

6

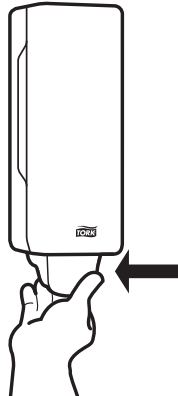

5

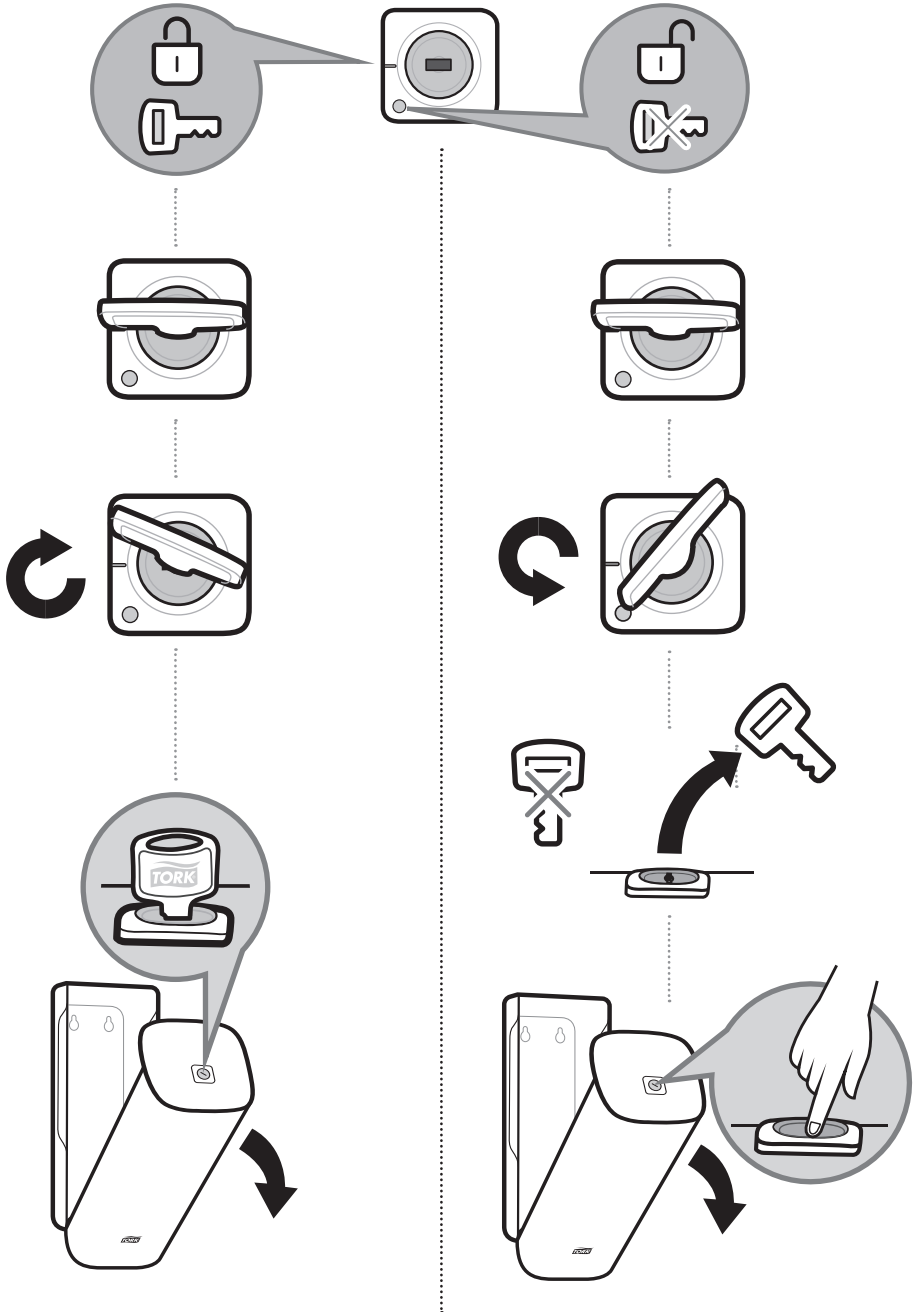

Disposal

- **Damaged or malfunctioning product should be disposed of immediately to avoid potential of injury**
- **Products should be disposed of in accordance with applicable regulations**

Cleaning instructions

- **Clean dispenser with mild detergent and soft cloth**

European Community Design Registration RCD 002601922



essity

Manufactured by Essity Hygiene and Health AB
SE-40503 Göteborg, Sweden
www.essity.com, www.torkglobal.com
Made in Poland